

Article number: 201241473A

Description: E+G Retaining magnets with threaded stud GN 52.4-AN-63-M12-E
Alu, Nickel, Cobalt - 450° C, 660N

Measures

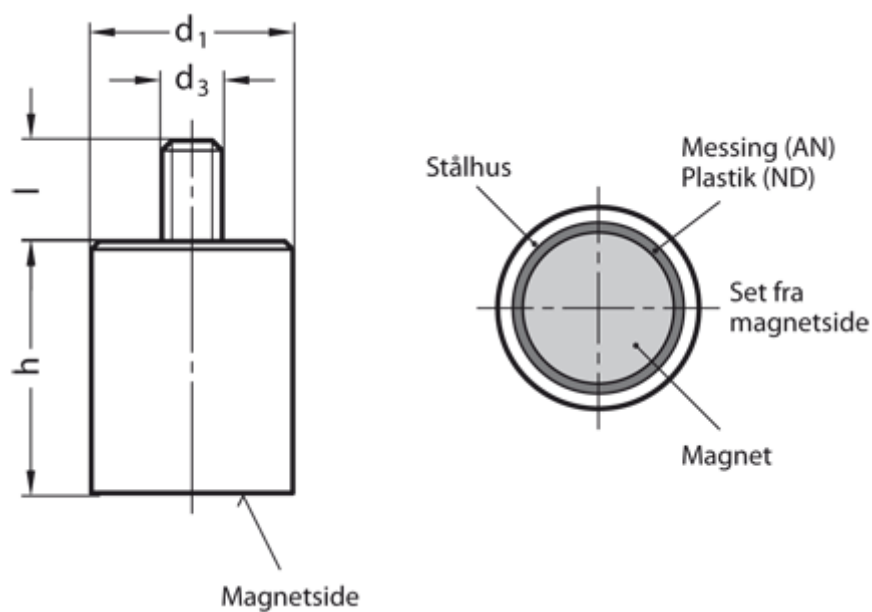

d1	= 63
d3	= M12
h	= 65 ±0,2
Holding force N	= 660.0
l	= 20
Material	= AN Alu, nickel, cobalt, 450°C